

T18 series

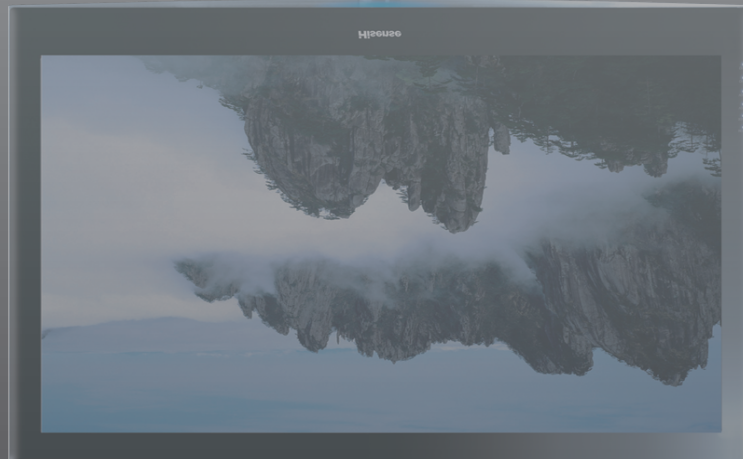

**Hisense**<sup>®</sup>

**User's manual**

Please read this manual carefully before operating your TV set and retain it for further reference.

Model Number:

Part Number:

[Http://www.hisense.com.au](http://www.hisense.com.au)

# HISENSE WARRANTY

## TERMS AND CONDITIONS

1. HISENSE Australia will provide parts and labour to you the Customer as set out herein.
2. Nothing in the warranty, limits any rights you may have under the trade practices act or any other Commonwealth or State Legislation. Such rights cannot be changed by the conditions in this warranty. Subject to the conditions below this appliance is warranted by Hisense and/or its Agents to be free from defects in materials and workmanship for a period of 12 months on DVD integrated models and 36 months on non combination models from the date of purchase (the "Warranty period")
3. This warranty: -
  - a. covers products purchased as NEW, manufactured for use in Mainland Australia and Tasmania;
  - b. commences from the date of purchase as listed on the Customers invoice;
  - c. provides for the labour and replacement parts necessary to maintain your product in good operating condition as specified in this warranty however, if repair is needed because of product failure during normal usage, Hisense has the option to repair or replace the defective product or part of the product with a product or part of the product of like kind and quality and a replacement part may be new or reconditioned of like kind and quality and may cost less than the original product purchased and no charges or refunds will be made based on the replacement product cost difference;
  - d. applies only to the original purchaser and cannot be transferred;
  - e. is only applicable when your appliance is used in a domestic environment;
4. Product Identification
  - a. Hisense reserves the right to reject claims for any services or work where the Customer requesting such work or services from Hisense and/or its agents cannot produce for verification the serial number and the proof of purchase as per original purchase invoice.
  - b. The warranty will be voided if any Serial Number sticker provided to be placed on the equipment is damaged, modified or removed.
  - c. In the event that a request for repair is made against a warranty where the Serial Number sticker is not attached to the product or the customer cannot produce for verification the original invoice, the repairer will not affect any repairs on the product and the Customer will be charged a service call-out fee.
5. What is covered by this warranty
  - a. The equipment is covered for faulty workmanship on parts that have failed under normal use which are contained within the product.
  - b. Hisense and/or its Agents will decide if there are any defects in the material and/or workmanship
  - c. This warranty is only applicable for repairs on declared equipment carried out within Mainland Australia and Tasmania
6. What is not Covered by this warranty (excluded):-
  - a. any damage or failure:
    - i. of equipment due to the product being inadequately serviced to manufacturer's recommendations;
    - ii. resulting from environmental conditions including and not limited to dirt, dust, rodents, insects, rust, corrosion, salt built-up, of any part of the product including its parts; or
    - iii. resulting from excessive use "fair wear and tear";
    - iv. resulting from poor installation including and not limited to positioning and externally fitted equipment such as plumbing and drainage, cabling, antennae or due to Incompatibility of connected equipment;
    - v. to the product caused by overheating as a result of siting or positioning of the equipment, where there is not provision for adequate ventilation or a dust free environment;
    - vi. caused if your appliance has been dismantled, repaired or serviced by any person other than someone authorised by Hisense;
    - vii. to a product or components, caused by power surges or spikes, including and not limited to, mains power and telecommunications connections, or to other unspecified sources, incorrect power current, voltage fluctuation, amperage fluctuation, rust or corrosion;
    - viii. due to a dropped product; collision with another object, use of which is not designed, negligence, accident or deliberate misuse, theft, abuse, vandalism, flood, fire, earthquake, electrical storms or any other act of God or any war related events;
  - b. costs of attendance and testing where no mechanical or electrical failure is identified;
  - c. initial setup and installation of the product;
  - d. Normal maintenance costs and costs incurred through the installation of items listed as requiring periodic replacement;
  - e. products with removed or altered serial numbers;
  - f. consumables such as but not limited to bulbs/globes, batteries, remote controls;
  - g. removal and reinstallation of an internal component not performed by a factory authorised service centre;
  - h. cosmetic or structural items;
  - i. Any failures due to the interference from or to other products and/or sources;
  - j. Inability of the product to read or output damaged or copied media;
7. The Warranty Ceases if: -
  - a. The product ceases to carry the original manufacturer's serial number or is sold at an auction;
  - b. The product is rented;
  - c. Damage to the product has occurred as listed in point 6b.
8. Neither Hisense nor its representatives provide loan equipment under the terms of this warranty.
9. Any unauthorised access to the internal hardware of the product will void this warranty.
10. Replacement items are "Like for like" and is not "new for old" and does not indicate in any way that a faulty product will be replaced with a new part or unit.
11. If you reside outside of the service coverage area of your nearest authorised service agent, this warranty does not cover the costs of transportation or travel expenses to and from your home.
12. Hisense accepts no liability for items that are lost, damaged, or stolen as a result of freight, transport or storage. If you are required to transport the appliance to an authorised service centre, you must ensure that it is securely packed and insured.
13. On Public Holidays or other periods when regular business and wholesale operations are temporarily ceased, repairer availability and warranty response times may extend beyond the standard response times due to the availability of repairers and parts.
14. Special Conditions relating to Plasma TV's, LCD TV's, Panels, Projection Television and Projections Equipment
  - a. All LCD and Plasma Panels exhibit some bright, dark or partially lit pixels, a normal limitation of these technologies, and the manufacturing processes involved and are usually not noticeable when viewing normal screen images and defective pixels are not a warranty issue unless they exceed the manufacturer's specifications for pixel defects. Where there are no manufacturer specifications, Hisense covers the screen provided for 12 or more pixels that are failing to display
  - b. Image retention or burn-in can be a problem for all phosphor based displays. In extreme cases, permanent phosphor burn can occur if still/repetitive images are left on the screen for extended periods of time. Such damage to the screen is not covered by the warranty. Please ensure that the precautions in any documentation supplied with your product are followed in order to avoid permanent damage to your display.
  - c. Where a product is positioned higher than 1.2m from the lowest mount point, is wall/ceiling mounted or where aftermarket mounts and/or stands are used, or where the unit has not been installed by a professional installer, an extra service charge will apply to unfix and refix this product.
15. Any repair performed on a product under the warranty where no fault can be found, or the item is deemed by Hisense, or an authorised Hisense agent, to be not faulty under this warranty, or the repair or fault is not covered under the warranty, a No Fault Found fee is payable by the warranty holder of a minimum of \$125 inc GST.
16. Any repairs or services required that are outside of the terms and conditions of the warranty can be carried out at the request of the customer or due to site attendance where fault is not covered under warranty as the product not been installed or setup correctly; a credit card may be required prior to the commencement of such services.

# WARRANTY CLAIMS PROCEDURE

Please retain this portion for your records

## 36 MONTHS IN HOME REPLACEMENT WARRANTY\*

Hisense Australia will provide its nearest service centre for repairs under warranty. You will need to ensure that you have already called Hisense Warranty Centre and received a JOB NUMBER.

*\*Non Combination Models only*

## 12 MONTHS IN HOME REPLACEMENT LCD WARRANTY\*

Hisense Australia will provide its nearest service centre for repairs or replacement under warranty. You will need to ensure that you have already called Hisense Warranty Centre and have received a JOB NUMBER.

*\* Excludes DVD Drive related faults which Hisense Australia provides a separate service stated below*

## 12 MONTHS COURIER HOTSWAP DVD DRIVE WARRANTY\*

Hisense Australia will provide a replacement removable DVD Drive, should you be experiencing DVD related faults, via courier which can easily be replaced by following the instructions for replacement within this manual.

*\*The faulty DVD drive must be returned to Hisense Australia or you may be liable for the cost of the part and freight*

**Before making a claim, please make sure that you understand the terms and conditions of the warranty**

- Check and ensure the installation of all power cables to the power point are secure and power is turned on, all cables leads and connectors are connected properly and that all switches are turned on and functioning
- Check that there is power at the power point by using a small appliance
- Check that all settings are set according to the instruction manual
- Please keep this certificate in a safe place together with your product receipt. Should you need to make a claim, the responsibility of proof of ownership of the equipment is on you. If a claim is made that is found not to be covered under this warranty, or no faulty hardware components are found, you will be charged at Hisense or Hisense Authorised Service Center's standard service charge plus an administration fee.

## PLEASE REFER TO THE TROUBLESHOOTING GUIDE AT THE END OF THIS MANUAL

### Service Procedure

Please have your **original invoice, model, and serial number** ready. To receive service, you are required to:

- Call **1800 447 367**. Service claims may be made between **9:00am and 5:00pm AEST** weekdays excluding public holidays where a call representative will log your claim for processing.
- You will be provided a **JOB NUMBER**
- You are required to fax or email your original invoice prior to a replacement been shipped
- Normally under 2 hours of logging and receiving your proof of purchase for your claim, an Authorised Service Agent will contact you to proceed with claim.

## WARRANTY REGISTRATION

In order to register your warranty, please fill out and return with a copy of your invoice to:

**Hisense Warranty Registration  
PO BOX 2268 Seaford Victoria 3198 Australia**

Congratulations on your purchase, This Document sets out terms and conditions of your product warranty. Please Keep it with your proof of purchase information in a safe place for future reference should you require service to your product.

The Undersigned hereby acknowledges receipt of the Hisense warranty service provided. I have read and understand the conditions and terms of the warranty in its entirety.

NAME OF PURCHASER \_\_\_\_\_

SERIAL NUMBER \_\_\_\_\_

ADDRESS \_\_\_\_\_

STORE PURCHASED FROM \_\_\_\_\_

CITY \_\_\_\_\_ STATE \_\_\_\_\_ POSTCODE \_\_\_\_\_

CITY \_\_\_\_\_ STATE \_\_\_\_\_ POSTCODE \_\_\_\_\_

PHONE (\_\_\_\_) \_\_\_\_\_

INVOICE NO. \_\_\_\_\_

MOBILE (\_\_\_\_) \_\_\_\_\_

MODEL NO. \_\_\_\_\_

FAX (\_\_\_\_) \_\_\_\_\_

DATE OF PURCHASE \_\_\_\_/\_\_\_\_/\_\_\_\_

SIGNATURE \_\_\_\_\_

*This page has been left blank intentionally.*

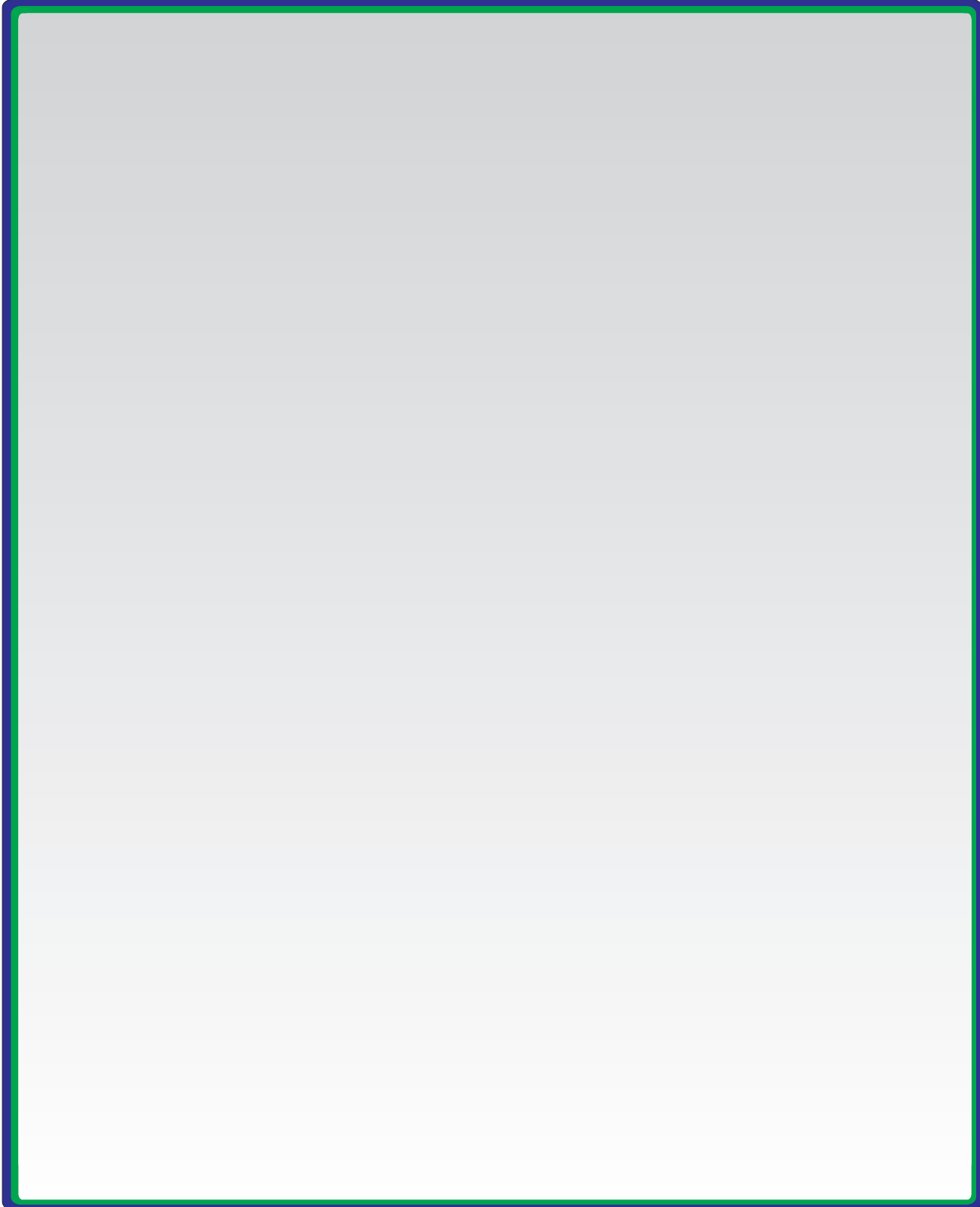

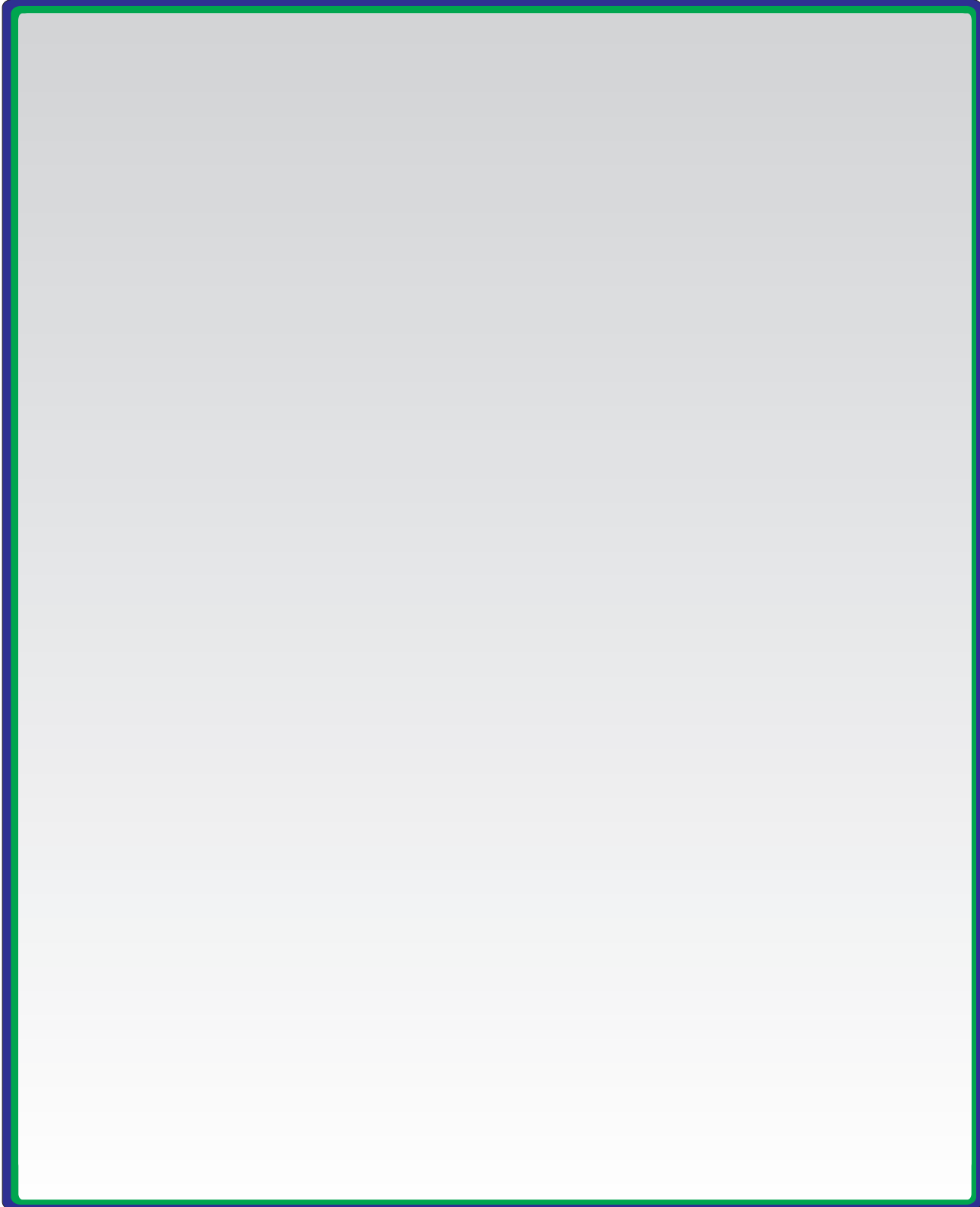



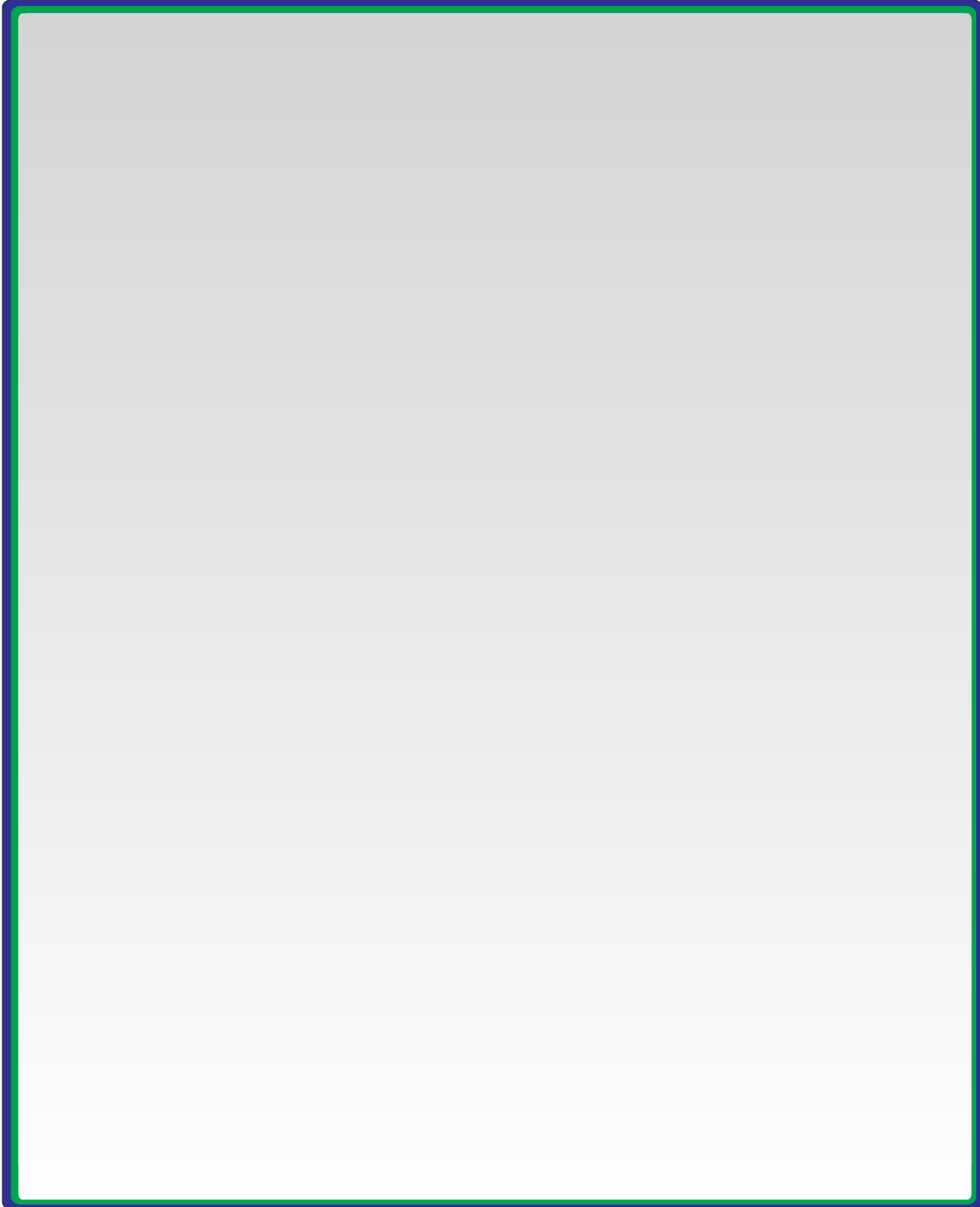



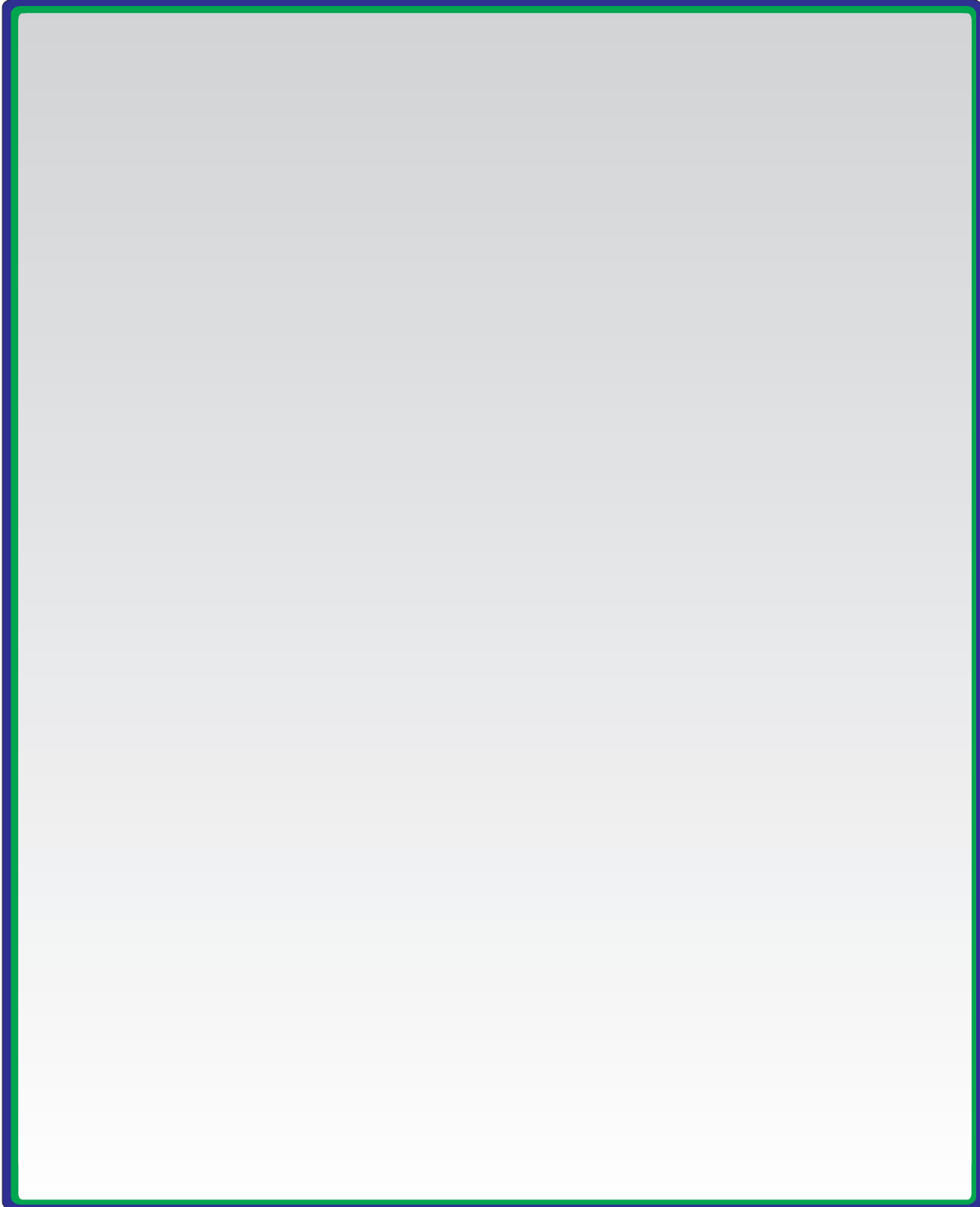







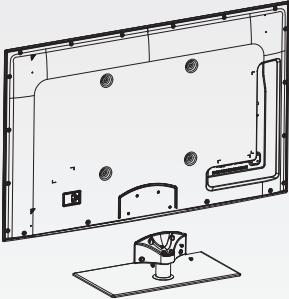
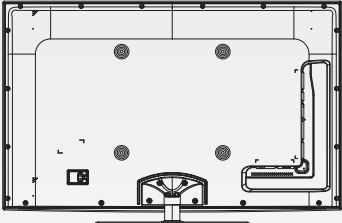





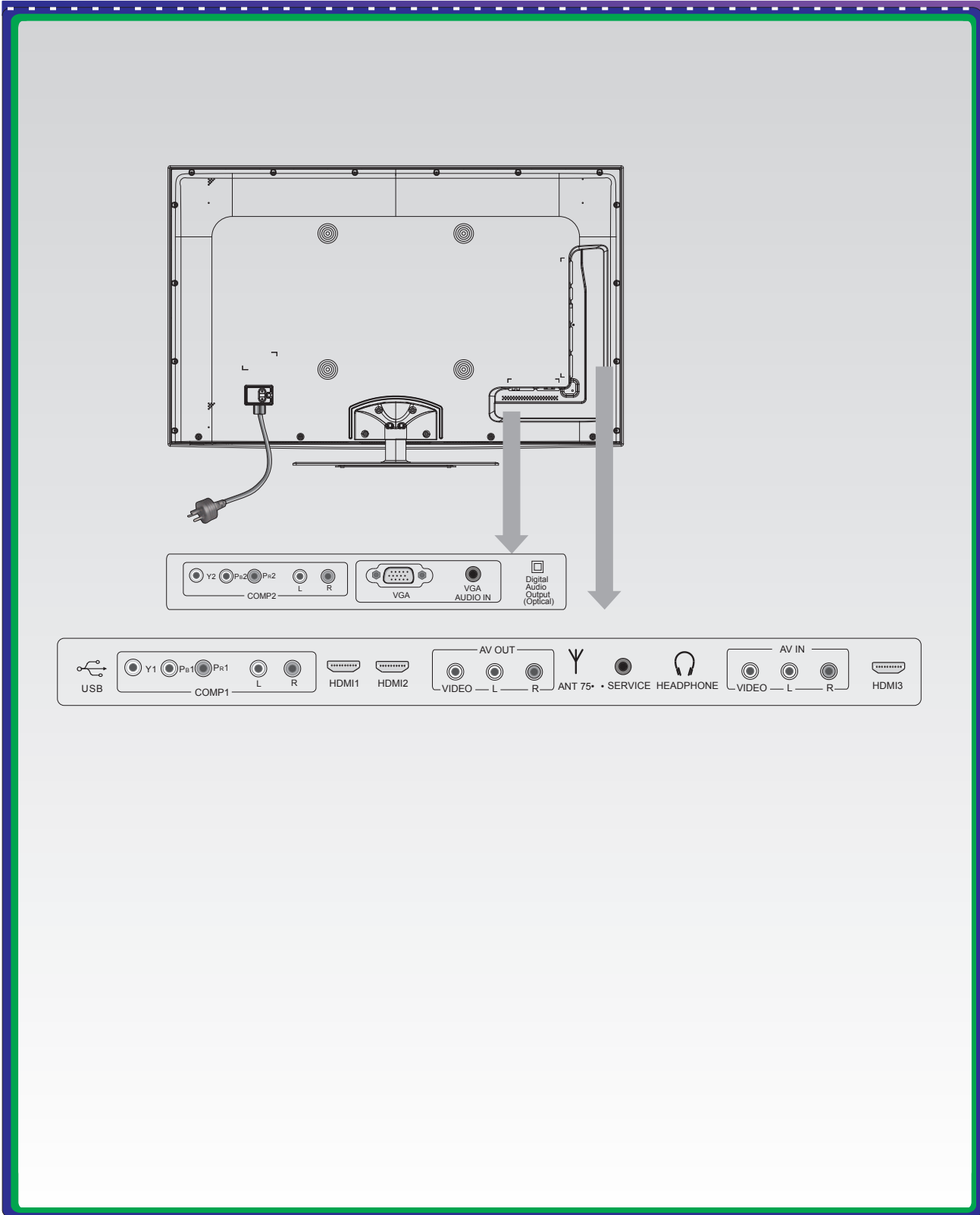





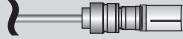























 a	 b	 c	
 d	 e	 f	 g

 (1)	 (2)
--	---







1				
2				
				
				
3				
				
				
4				
				
				
				
				
5				
6				
				
7				
8				
9				

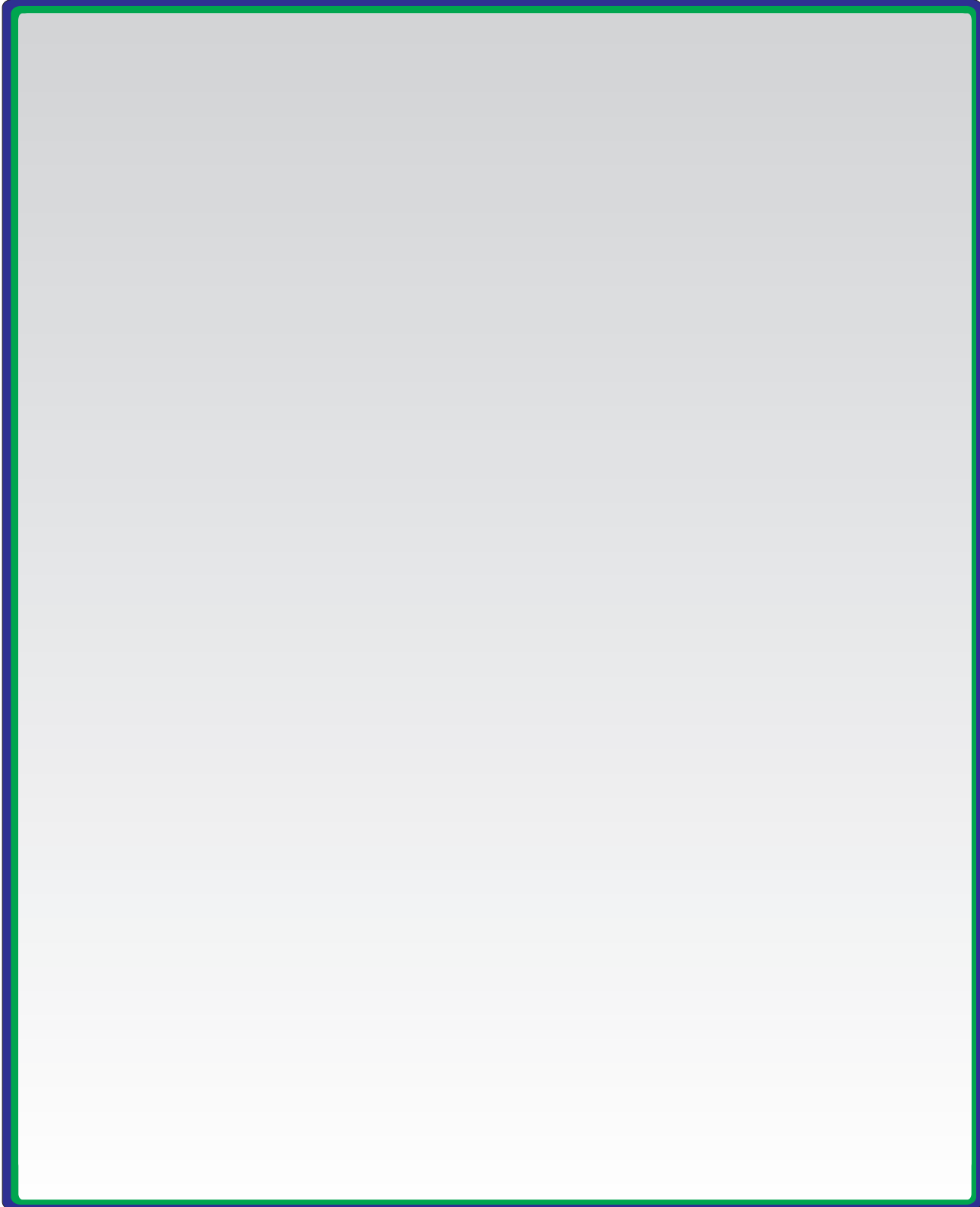

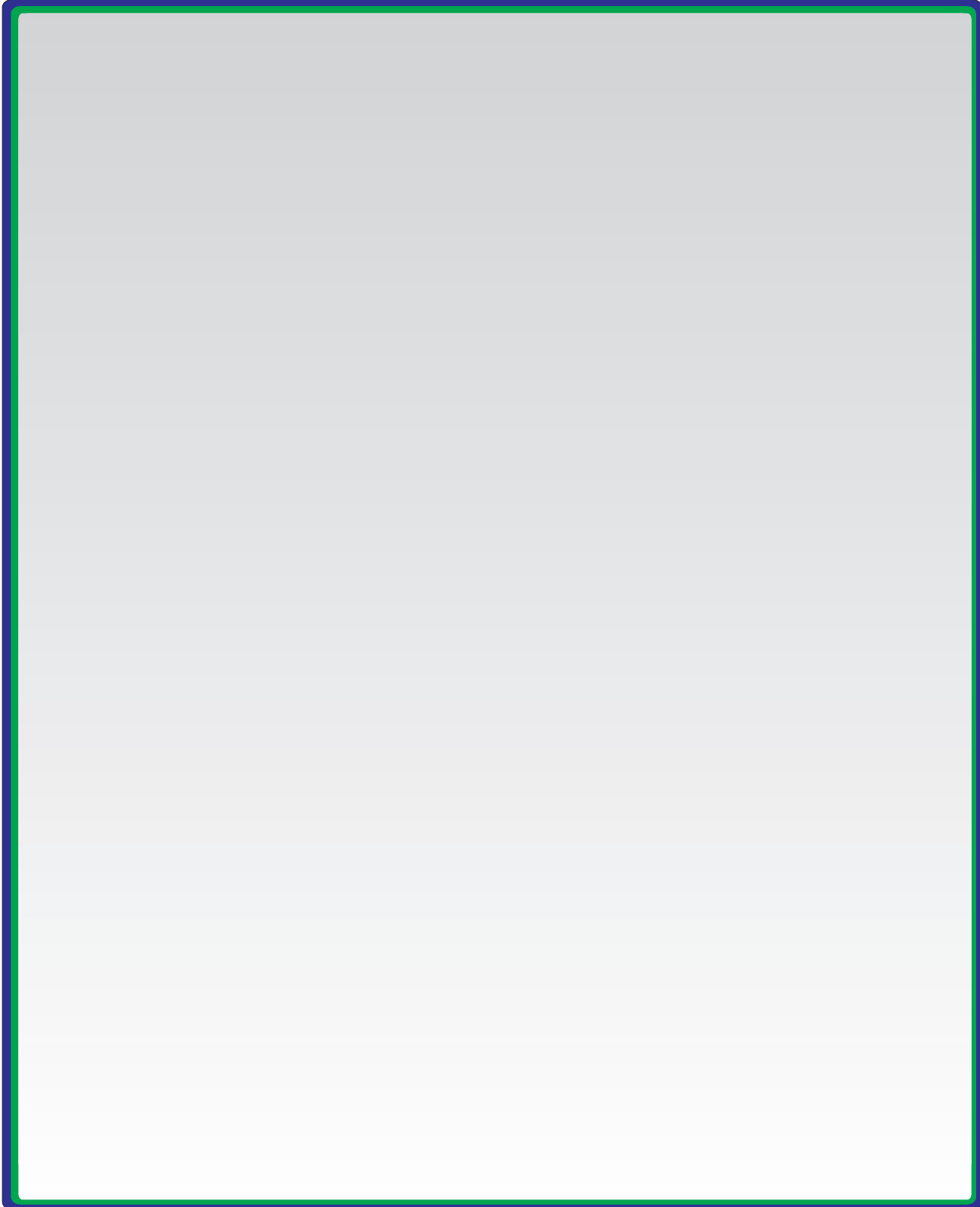

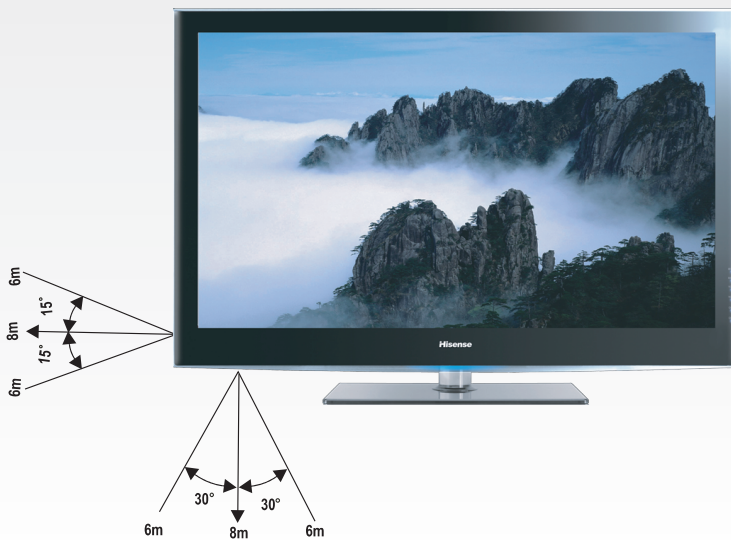





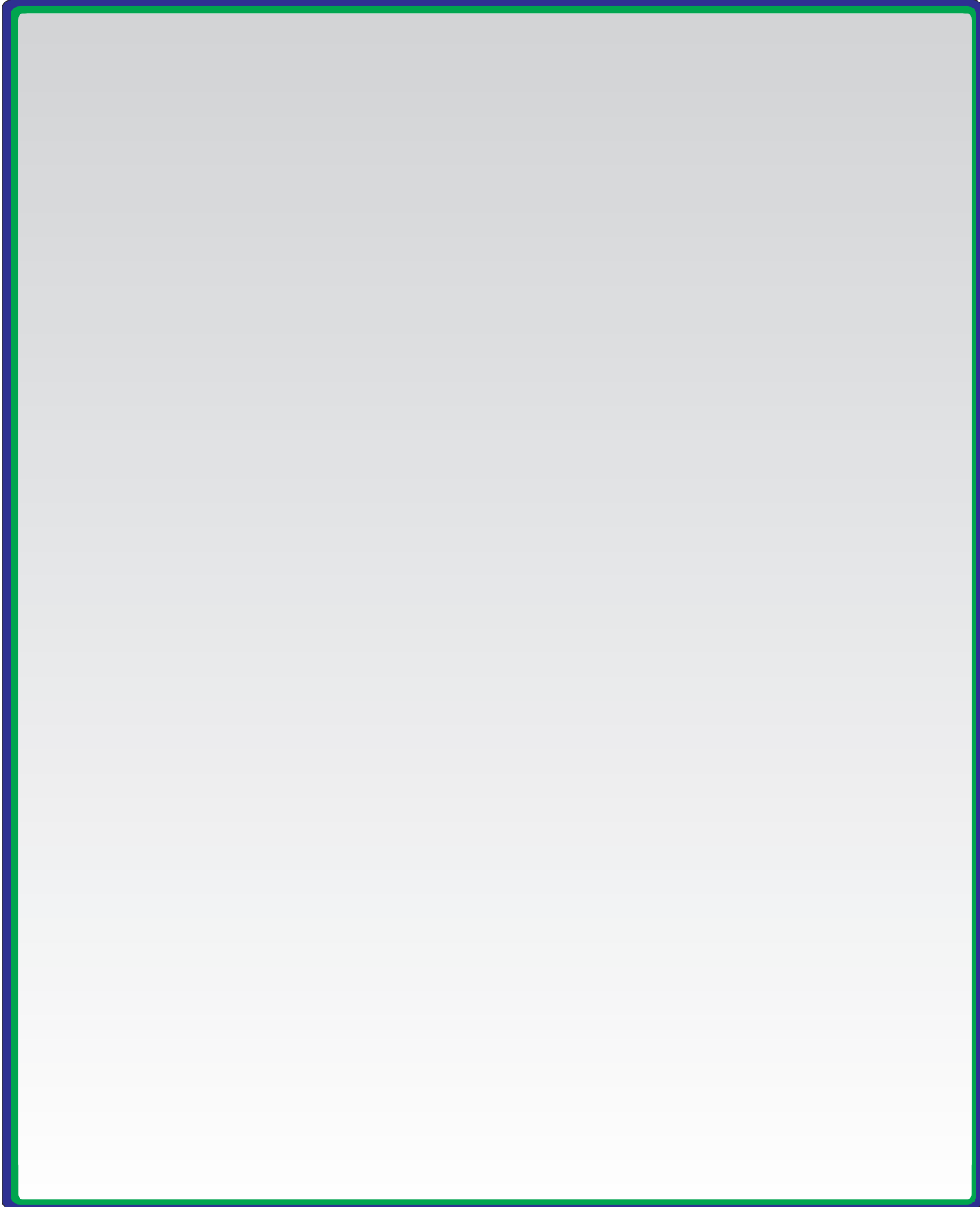

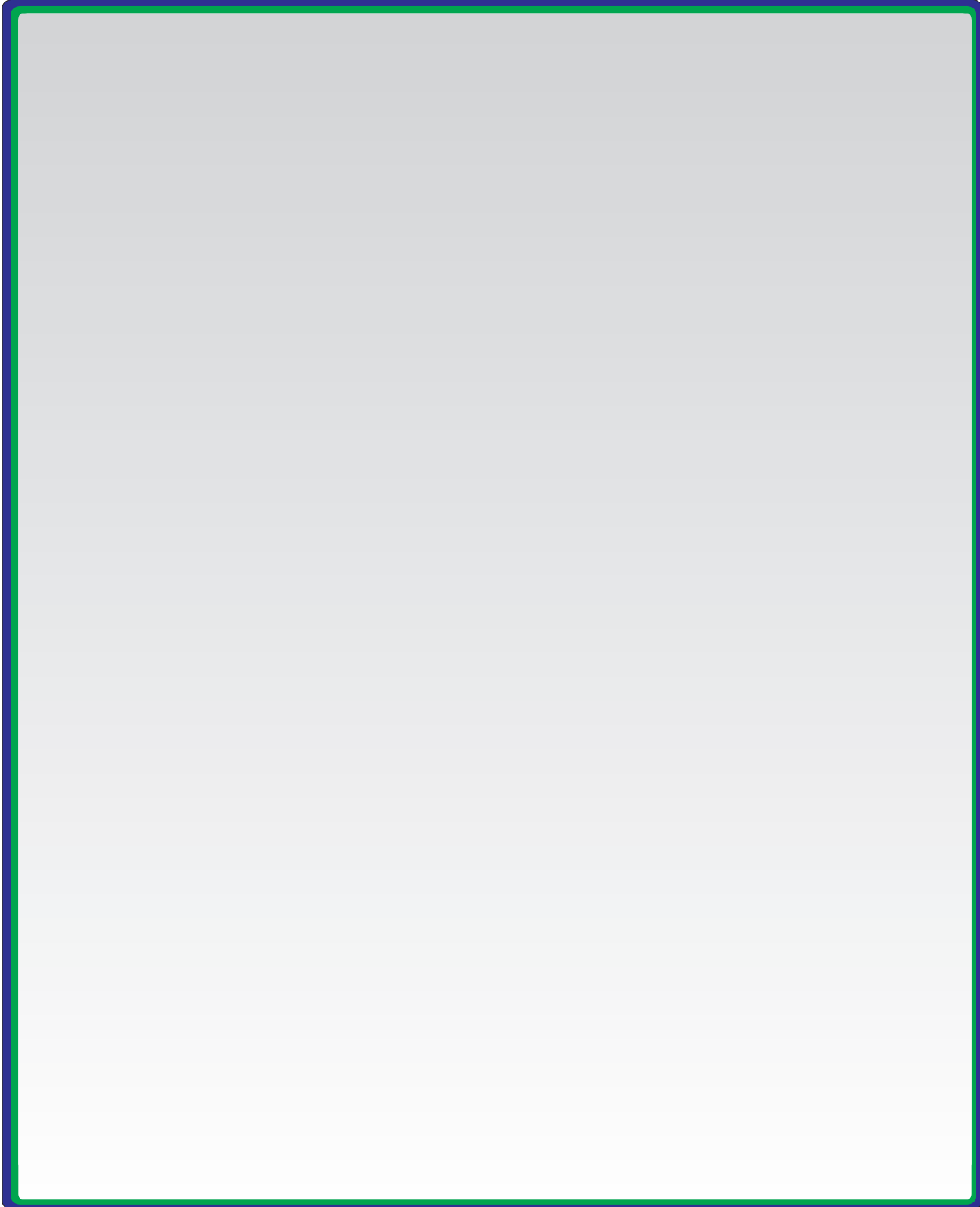



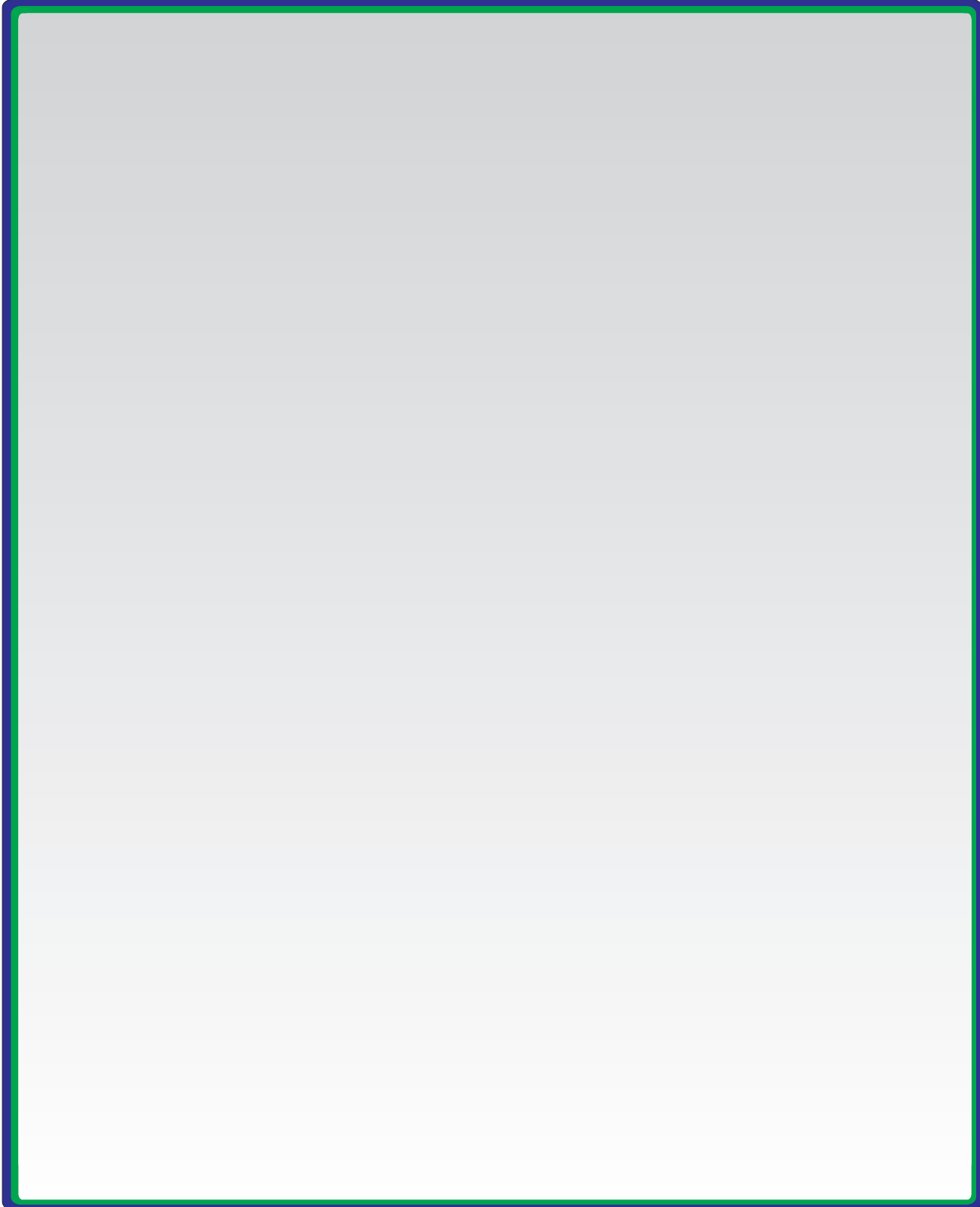



Picture Mode	Standard
Brightness	50
Contrast	50
Color	50
Sharpness	50
Tint	0
Back Light	100
Color Temperture	Standard
Aspect Ratio	16:9
Nosie Reduction	Auto
Memo	Off
OK → Enter ↑↓ Select ≡ Return	



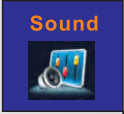

Sound Mode Standard  
Equalizer  
Balance 0  
AVC Off  
SPDIF Output PCM  
OK → Enter ↑↓ Select ≡ Return





Function

Blue Screen	On
Startup Menu	Off
OSD Time Out	60 Sec.
Time	
Factory Reset	
Turn On Light	On
OK → Enter ↑↓ Select ▢ Return	





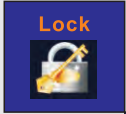

OK → Enter ↑↓ Select ☰ Return



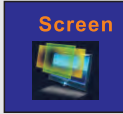

Position  
H\_Size            50  
V\_Size            50  
  
OK → Enter ↑↓ Select ⇧ Return



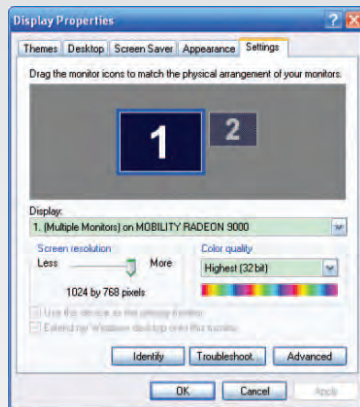
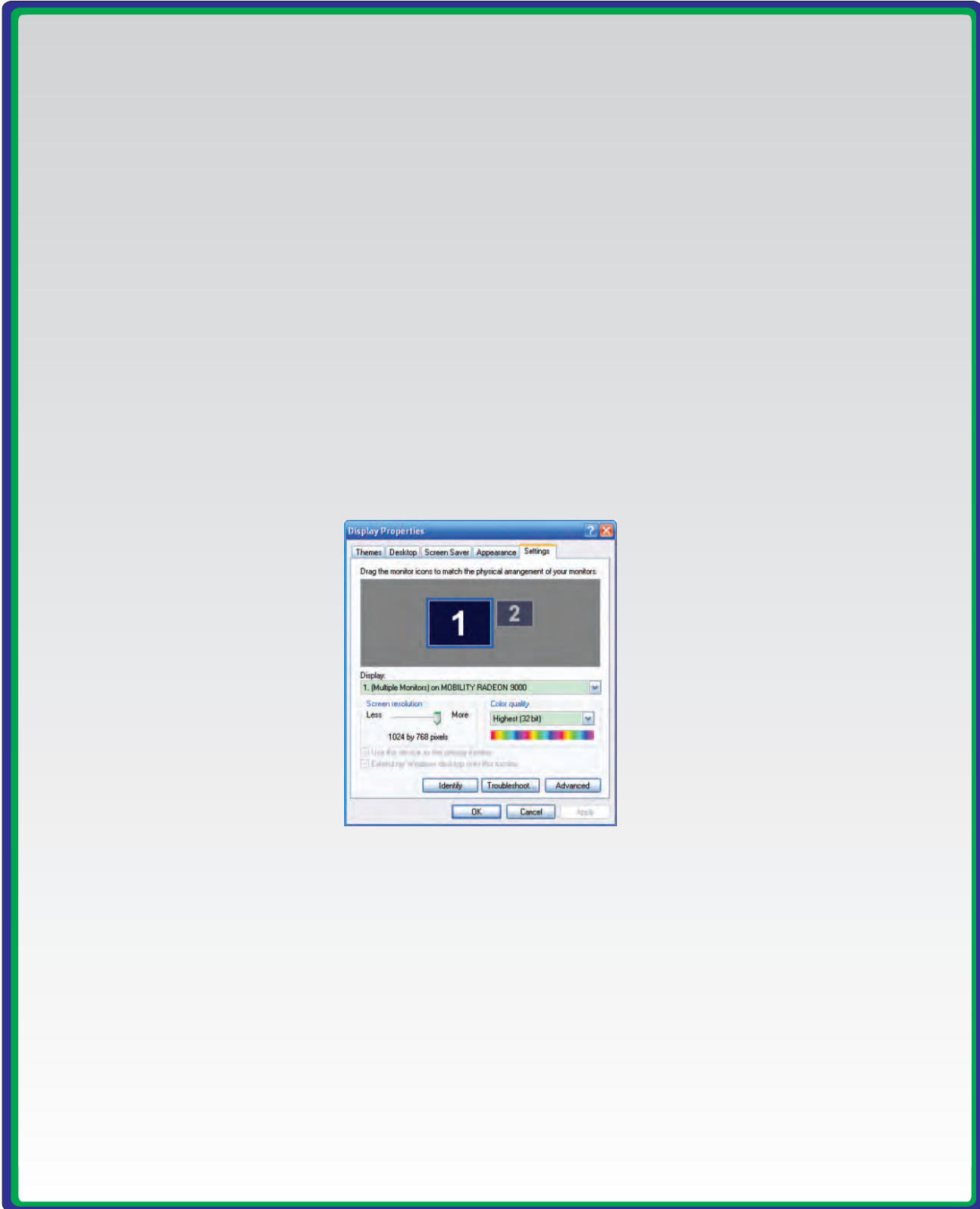

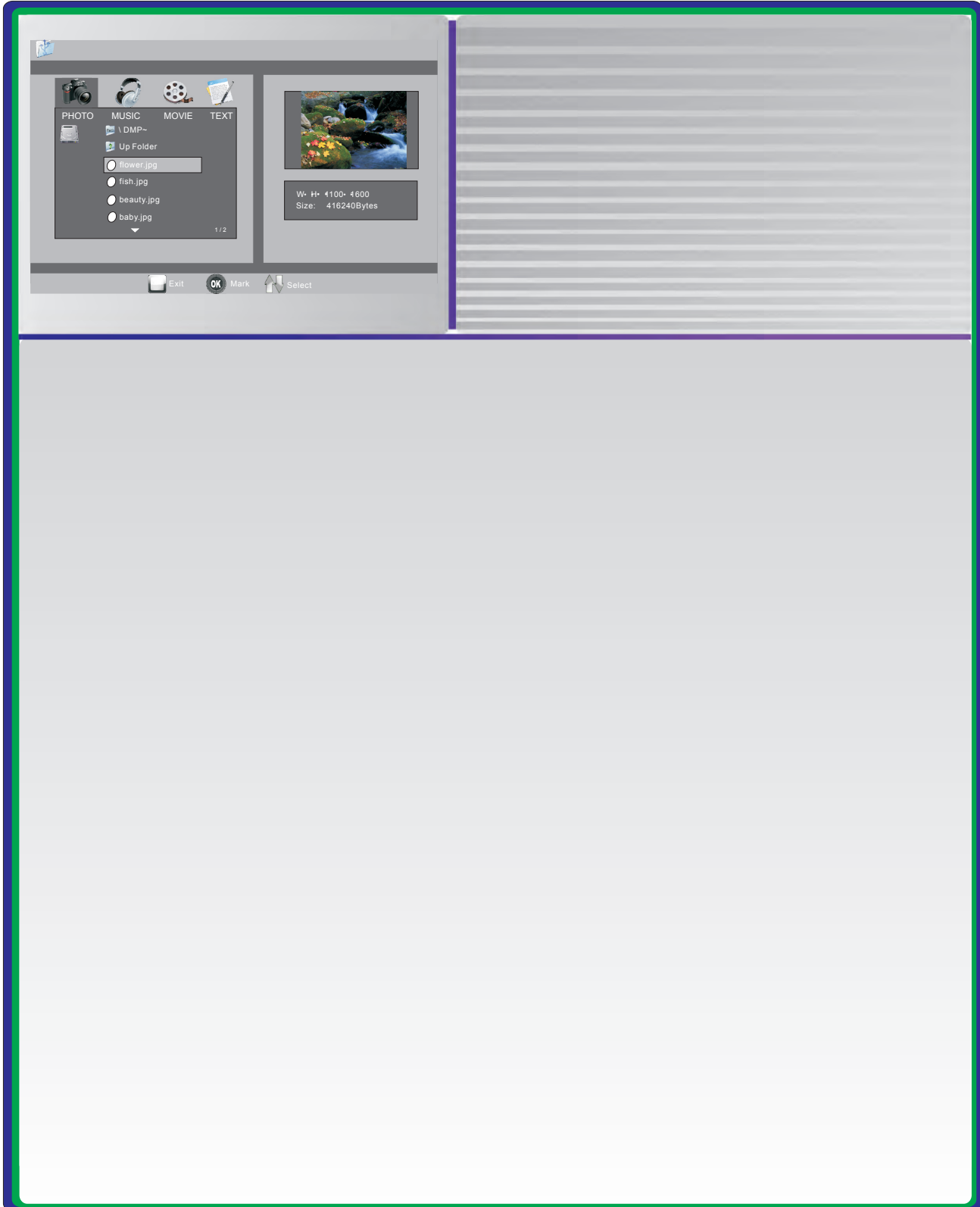

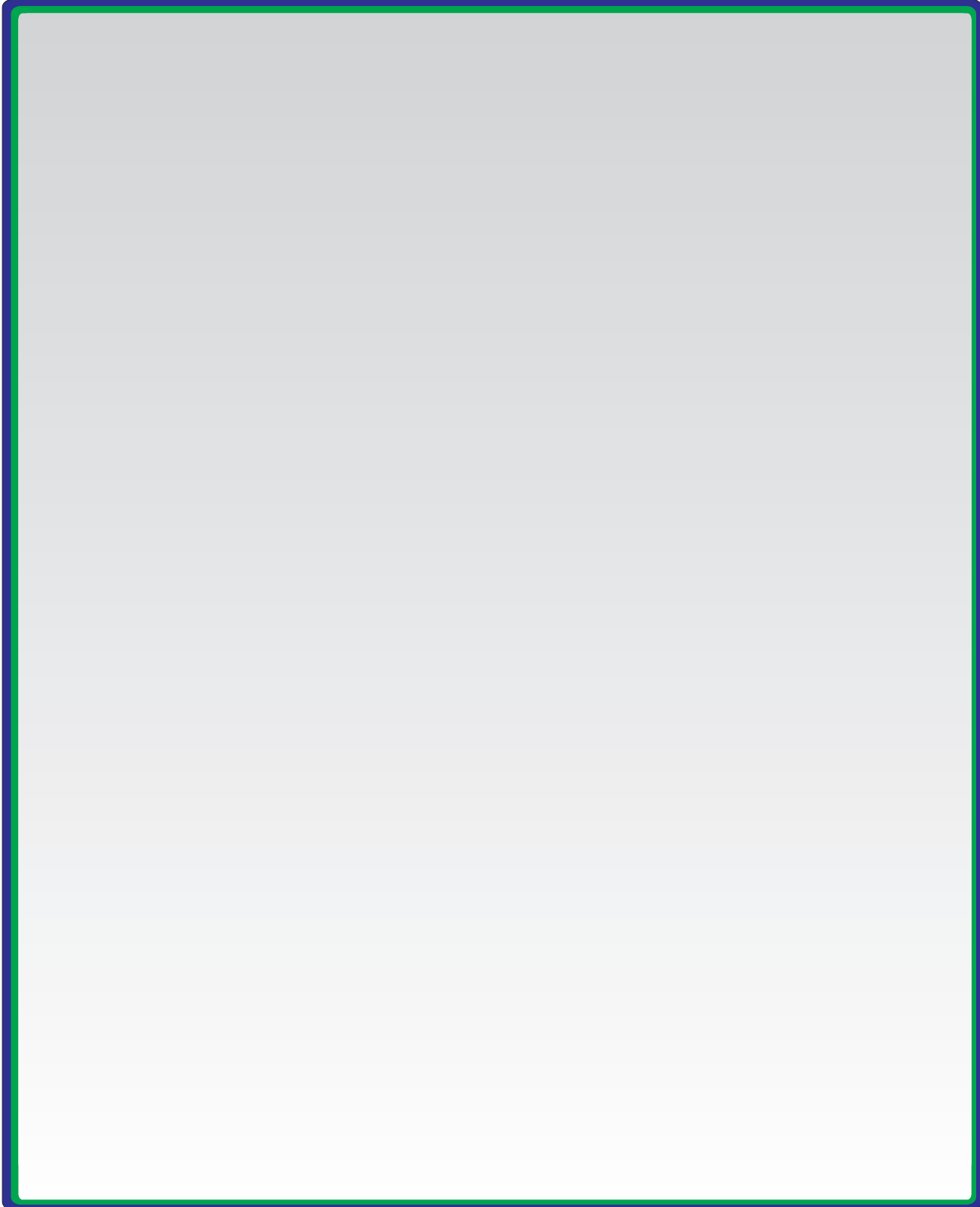





**Hisense<sup>®</sup>**

[Http://www.hisense.com.au](http://www.hisense.com.au)